



How to install and operate the DLS Reference series car audio amplifiers RA20 & RA40.

Welcome!

This owners manual is written in easy english and uses a lot of drawings to simply the installation and use of the above amplifiers.

Your DLS amplifiers must be installed correctly in order to work well. This manual will show you how to install the amplifier like a pro. Please read the entire manual before beginning the installation. Install the amplifier yourself if you feel confident with our instructions and if you have the proper tools. However if you feel unsure, turn over the installation job to someone better suited to it.

Warranty Service

This amplifier is covered by warranty, depending on the conditions in the country where it is sold. If the amplifier is returned for service, please include the original dated receipt with the product.



Technical Assistance

For technical assistance ask the shop where the product was sold or the distributor in your very country.

You can always phone the DLS Helpdesk in Sweden + 46 31 84 00 60 or send an e-mail to info@dls.se. Information can also be found on our WEB-site www.dls.se

Contents

Features.....	2
Installation.....	2
Tools and materials needed.....	3
Amplifier installation kit.....	3
Routing Wires.....	3
Wiring:	
Power and Outputs.....	4
Input and controls.....	5
Input wiring.....	5
Input level control.....	6
Grand Bass.....	6
Phase control.....	6
Crossovers.....	6
RA20 speaker wiring:	
Front speakers.....	7
Subwoofer.....	7
RA40 speaker wiring:	
Four speakers.....	8
Two speakers + bridged subwoofer.....	8
Two speakers in bridge mode.....	9
Testing.....	9
Troubleshooting.....	9
Professional tips.....	10
Specifications.....	11



RA20



RA40



All models include

- ♦ RCA inputs
- ♦ High Level input
- ♦ Continuous variable low pass and/or high-pass crossovers
- ♦ Grand bass feature 0 - +18 dB
- ♦ Phase shift continuously variable 0-180 degr.
- ♦ Remote turn on / off
- ♦ Automatic remote turn on/ off on high level input without connecting any remote wire
- ♦ Electronic protection circuitry against short-circuit, DC offset and thermal overload. Bridgeable design to direct full power to one or two speakers.

Installation

Before you begin installation

Before you begin you need to read the manual, to have some tools, cables and other material available. There is one such list of material on the following page.

Amplifier location

Important

Allow air circulation around the amplifier.

The DLS Reference series of amplifiers have a compact design that allows great flexibility in mounting. You can mount it under a seat or in the trunk.

When you select a location, do remember that the amplifier generates a lot of heat.

Choose a location where air can circulate freely around the amplifier. Do not cover the amplifier with carpets or hide behind trim panels.

Do not mount the amplifier in an inverted or upside down position.

Check all locations and placements carefully before making any cuts, drilling any holes or making any connections.

This is the best way to mount the amplifier to get the best cooling.



Disconnect Battery

Before starting the installation, always disconnect the negative terminal of the battery.

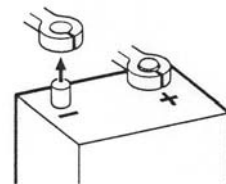

DLS logo on amplifier cooling flange

The DLS logo on top of the amplifier is attached with two hex. screws. The logo can be removed and twisted 90 or 180 degrees, and then screwed back in wanted position. The logo can be mounted in four different ways to match your installation.

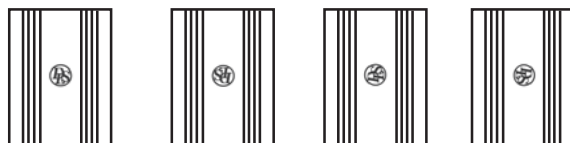

Tools and material needed

Tools:

- ◆ Flat and Phillips screwdrivers
- ◆ Wire cutter
- ◆ Wire stripper
- ◆ Electric drill with drills
- ◆ Crimping tool
- ◆ Digital multimeter or test lamp
- ◆ Wire brush, scraper or a piece of an abrasive sheet to remove paint for a good ground connection
- ◆ Grease to protect the ground connection from oxidation

Material:

- ◆ Speaker wire: minimum 12 AWG = 4 mm² for subwoofers
13 – 16 AWG = 1,5-2,5 mm² for other speakers
- ◆ Sheet metal screws for mounting the amplifier to the amplifier board and the amplifier board to the car + some extra for fuse holder, amplifier ground etc.
- ◆ Electrical insulation tape
- ◆ ½ inch thick plywood or particle board for the amplifier to be mounted upon.

Amplifier installation kit:

If available, buy an amplifier installation kit. It contains normally all you need. This is what you have to buy if you buy the items separately

- ◆ 20- 25 feet = 6- 7.5 meter power cable, minimum AWG 5 = 16 mm² or heavier
- ◆ 1 pc of fuseholder to install close to the car battery + fuse 50 Ampere.
- ◆ 20 feet of AWG 15 = 1,5 mm² wire for remote turn on / off cable from radio.
- ◆ RCA-cable for input from radio.
- 20 feet or 5 meter for trunk installations
- 12 feet or 2 – 3 meter for under seat installations
- ◆ Two ring crimp terminals –one for connection to the battery plus and one for the amplifier ground connection.
- ◆ Four to eight splicers to connect speaker cables to high level input cable, if high level input is used.
- ◆ Wire ties
- ◆ Insulating grommet or insulating tube

Routing wires

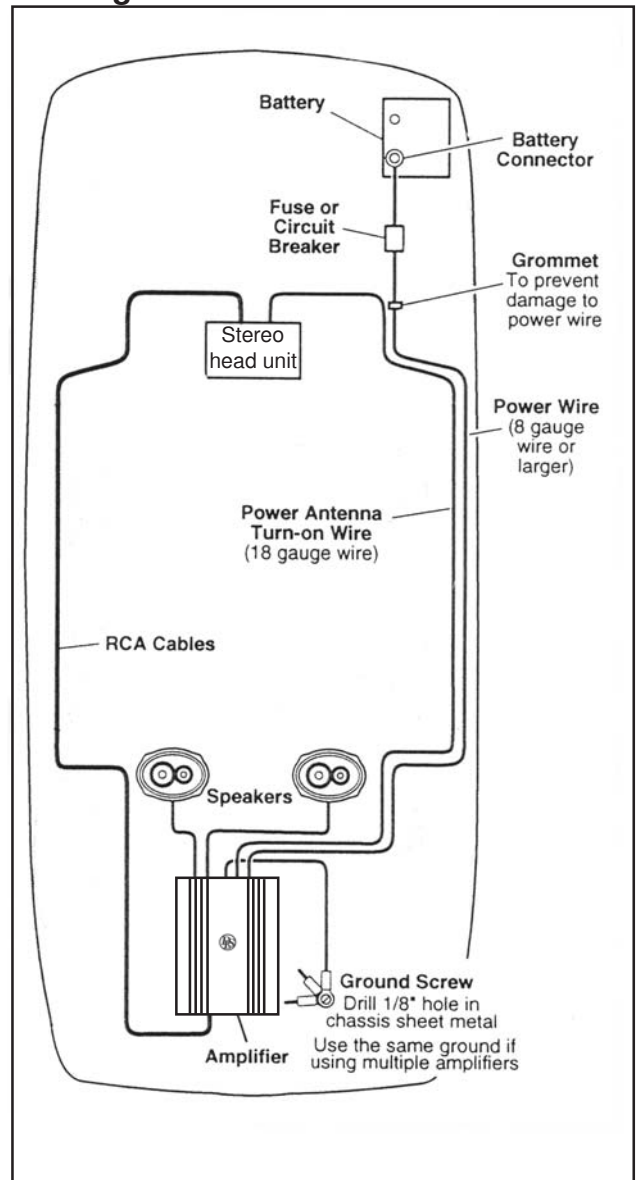

Professional Tip:

If amplifier installation kits are available with different size of power cable, choose the most heavy power cable to improve sound quality and to allow more amplifiers to be installed now or later.

Use minimum AWG 5 = 16 mm² cable, but if possible buy AWG 4 = PL 21 mm² cable for best performance.

The ground cable must have the same size.



Wiring

Power and Outputs

Power terminal (+12V)

Connect the fuse holder as close to the vehicle battery + as possible, using AWG 5 = 16 mm² or heavier cable. Use ring crimp terminal cable to connect to battery +. Apply silicon grease to the fuse to prevent corrosion. Use a 50 Amp fuse.

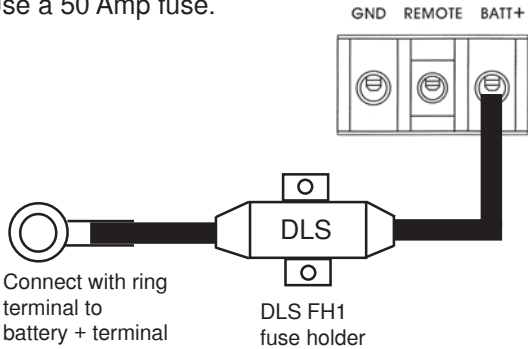

Connect the battery cable from the fuse holder to the +12 Volt terminal on the amplifier. Be sure to use a rubber grommet or a plastic insulating tube where the cable passes the firewall or other places when it can easily be jammed. Use ty-wraps to secure to existing cables in the engine compartment.

Ground Terminal (GND)

Connect to a good chassis ground. The ground connection should be clean, unpainted metal to provide a good electrical connection. Use a wire brush, a scraper or a piece of an abrasive sheet to clean the metal. Use a lock washer or two to secure contact. Protect with silicon grease or by paint applied afterwards.

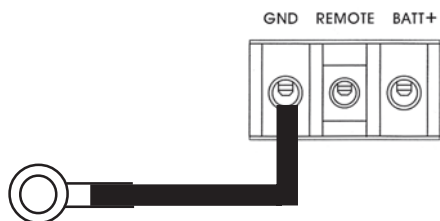

Connect with ring terminal to chassis ground

Fuses

Use only two 25 ampere ATC blade type fuses.

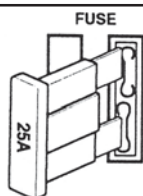

Remote terminal (REM)

For RCA cable signal input:

Set the input selector switch to position "Low level". Connect the radio power antenna lead = remote turn on/off from the car stereo to the amplifier remote connection. This turns on the amplifier whenever the car stereo is turned on.

You can either use the built in remote cable in the RCA cable itself or use a separate cable as seen on page 4.

Sometimes a small disturbance may enter the amplifier coming from the remote voltage, through the built in remote wire and into the RCA cable. Thus we recommend to use a separate remote wire and run the RCA lead separate from remote wire, power cables and speaker cables.

Insert the cable directly into the amplifier terminal. If there is no remote voltage available from the stereo, you must connect to the ignition key through the radio or any accessories fuse.

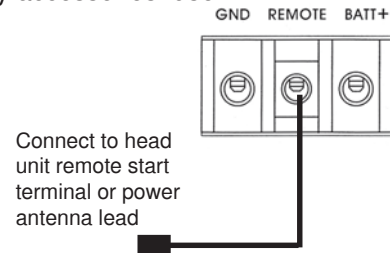

For High Level input:

Set the input selector switch to position "High level". We recommend you to connect the remote wire as described above. The amplifier will produce soft on / soft off operation this way. If you use a remote wire, set the switch "High level auto start" to position OUT.

In the case that there is no remote voltage available from the car stereo, or you want to simplify the installation, the amplifier can be turned on/ turned off by the high level input voltage. This is done when the "High level auto start" switch is set to IN - position.

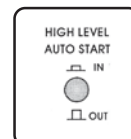
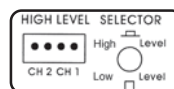

Power Light / Protect light

- Power (Green) ● The power light (green) comes on when the amplifier is turned on.
- Protect (Red) ● The protect light (red) comes on when the amplifier shuts down from overheating, or a short circuit (speaker failure)

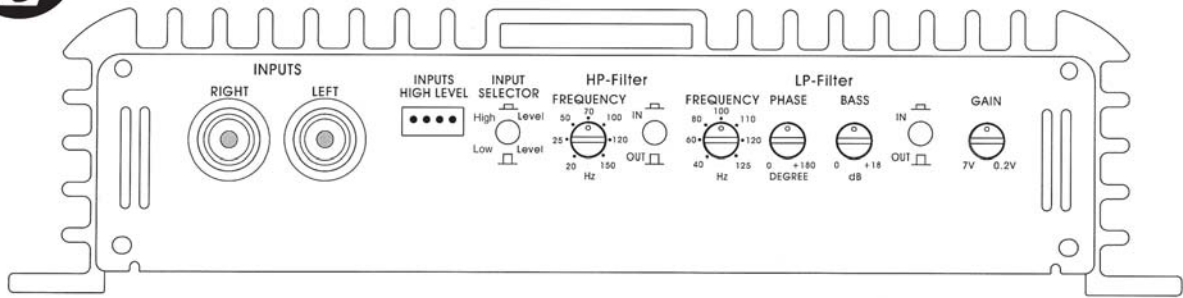

Input Wiring

Inputs may be low level from the RCA output of the car stereo or high level from the car stereo speaker output. Low level = RCA is to prefer for the best sound quality.

Low level input

Use a pair of shielded stereo audio cables with RCA type jack. Most trunk-mount amplifiers need a 20 feet RCA cable (appr 5 – 6 meters). Most under the seat installations require 12 feet (2 – 3 meters) RCA cables. Avoid placing the RCA cable close to speaker cables, power cables and remote control cable. Connect to RCA input sockets.

Set the input selector switch to position "Low level".

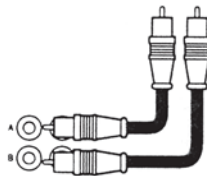

High Level Input for ch 1 & 2 on RA20 and RA40

Connect left and right speaker wires coming from the car stereo to the high level input as shown. You must connect both plus and minus as the inputs are balanced, connecting plus only gives lower level and bad sound quality. By changing the polarity of plus and minus, you can change the phase.

High level input socket for CH 1 & 2

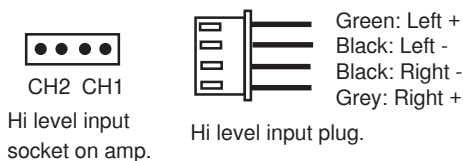

Automatic turn on when using high level input.

With the "Input selector switch" set to High level and the "High level Auto Start" switch set to IN, the amplifier turns on automatically on high input. You don't need to connect a separate remote wire from your head unit.

If you want to use high level input but use a remote start wire, just set the "High level Auto Start" switch to OUT.

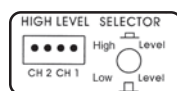

RA40 high level input for ch 3 & 4.

The RA40 four channel amplifier is connected likewise, however we have four channels.

You can feed all four channels using high level input, or feed two channels from RCA and two channels using high level input from rear speaker cables.

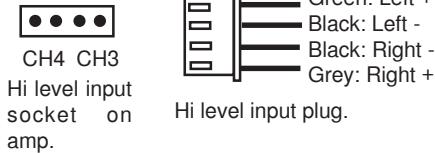

High / Low level input switch

To ensure best possible performance from the amplifiers a switch is installed to select between Hi and Low input.

When using High Level input:

Push in the button to position "High Level"

When using Low level input:

Push out the button to position "Low Level"

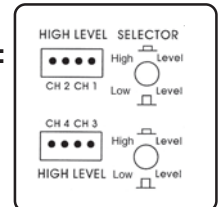

Hi level auto start switch

To ensure best possible performance from the amplifiers when used with high level input a switch is installed to select between Automatic amplifier start and remote wire start.

When using High Level input with automatic start:

Push the button to position IN

When using High level input with remote wire start:

Push out the button to position OUT

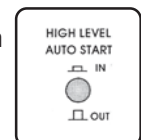

NOTE!

Some head units use BTL output IC:s that have a constant 12 Volt + on the speaker terminal, also when shut off (the Power LED indicator lights constantly even when the head unit is off). In this case you have to use a separate remote wire connected to the REMOTE-terminal instead.

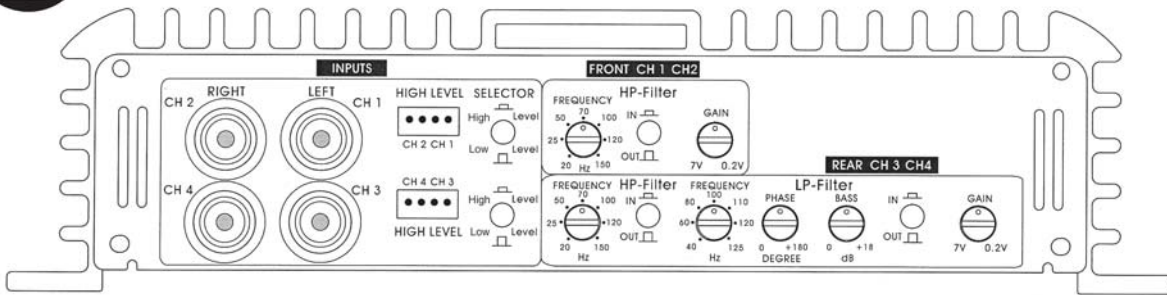

Input Level control

The input level control, 7V – 0,2 V, matches the output of your radio to the input of the amplifier. After installation is complete, make sure the input of the amplifier is turned down all the way (counter-clockwise at 7V).

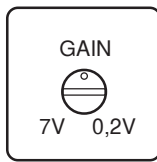

Play a tape or CD, make sure all bass or treble settings or equalizer are flat, and turn the volume of the radio up until you just start to hear distortion. Turn the volume control down just a bit. On the amplifier increase the input level control (clockwise or to the right) until you just start to hear distortion, then back the level control just a bit. Now your radio and amplifier levels are matched.

Grand bass 40 Hz

Grand Bass is used to increase the bass volume with a center frequency of 40 HZ. You can select the amplification between 0 dB (no amplification) and +18 dB (full amplification).

This function is used to compensate for the bass box function and to adjust for your own taste of bass. Set level control at 0 dB if you want it to be inoperative. On RA40 this function is operative only on channels 3 & 4.

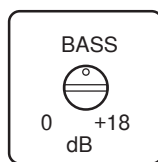

Phase control

The phase control on RA20 & RA40 can be set continuously from 0 - 180 degrees. This is very useful when you want to adjust the bass sound for best front stage image. Start on 0 and turn the control slowly clockwise until you experience that the bass sound is coming from the front. If you dont get the result you want, also try to phase reverse the subwoofer connections and make a new adjustment.

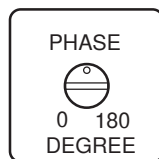

Crossovers

The DLS Reference amplifiers include high pass filter (HP) and low pass filters (LP). The highpass filter can also be used as a subsonic filter.

All filters are continuously variable and all filters can be switched on and off.

The slope of all filters are 12 dB / octave.

The filter can be switched off if you want to run the amplifier in full range mode.

This is the crossover configuration on RA20 & RA40:

RA20:

LP-filter 40 - 125 Hz

HP-filter 20 - 150 Hz

RA40 CH1 & 2:

HP-filter 20 - 150 Hz

RA40 CH3 & 4:

HP-filter 20 - 150 Hz

LP-filter 40 - 125 Hz

High Pass Filter / Subsonic filter

The **HPF** (high pass filter) blocks very low frequencies from reaching the speakers. It is mostly used at say 60 Hz to protect small speakers (like 6 inch and smaller) from deep bass. It can also be used as subsonic filter to take away the very deepest frequencies from a bass box. The typical setting is then around 25 – 40 Hz.

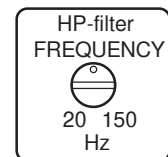

Low Pass Filter

The **LP-filter** (low pass filter) is mostly used for subwoofers. It will allow low frequencies only and blocks higher frequencies.

A typical setting is 50 – 80 Hz.

The filter can be switched IN-OUT and is available on both RA20 and RA40.

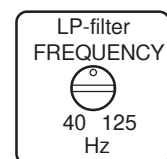

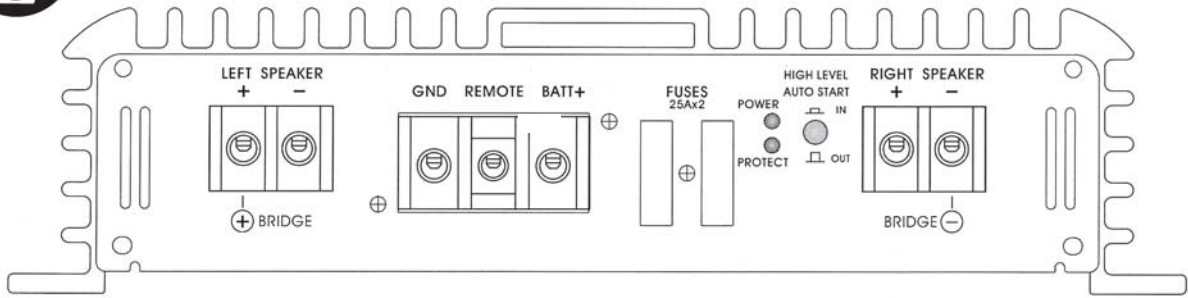

Speaker wiring RA20

RA20 is a 2-channel stereo amplifier. It can be connected either as a stereo amplifier for fullrange speakers, or as a mono amplifier for subwoofers connected in bridge mode.

Two fullrange speakers connected in stereo mode

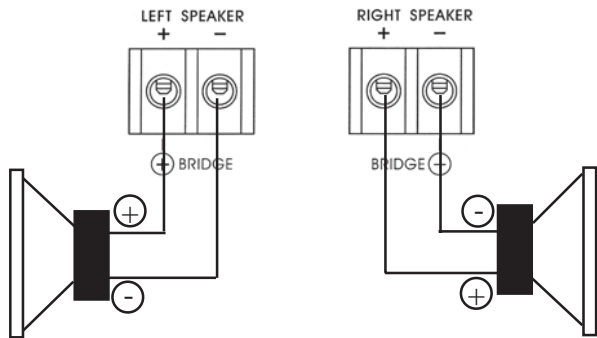

Filter settings

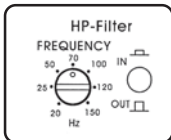

With the **HP-filter** in **OUT** position the amplifier allows the speakers to play fullrange. If you for some reason want to limit the low bass reproduction switch IN the HP-filter. The typical setting is then around 60 – 80 Hz.

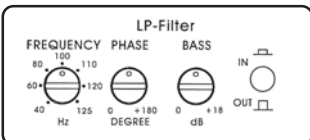

The **LP-filter** should be OFF (switch in **OUT**-position).

One subwoofer connected in mono bridge mode

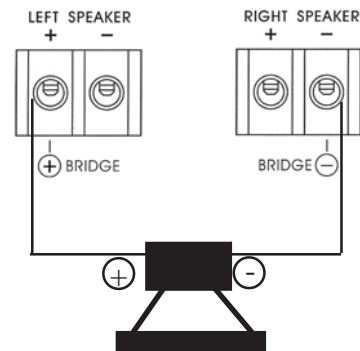

NOTE!

4 ohm minimum load when using bridge mode connection. Lower impedances may damage the amplifier. In bridge mode the amplifier sees a 4 ohm load as 2 ohm.

Filter settings

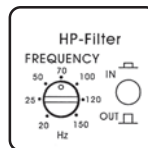

The **HP-filter** is here used as subsonic filter to take away the very deepest frequencies from the subwoofer. The typical setting is around 25 – 40 Hz.

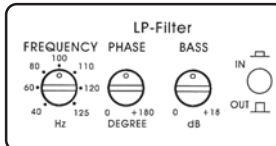

The **LP-filter** will allow low frequencies only and blocks higher frequencies. A typical setting is 70 – 90 Hz. When used with a subwoofer the switch should be in **IN**-position. Set the LP-filter to 70-90 Hz.

BASS is used to increase the bass volume with a center frequency of 40 Hz. You can select the amplification between 0 dB (no amplification) and +18 dB (full amplification).

The phase control can be set continuously from 0 - 180 degrees. This is very useful when you want to adjust the bass sound for best front stage image. Start on 0 and turn the control slowly clockwise until you experience that the bass sound is coming from the front. If you don't get the result you want, also try to phase reverse the subwoofer connections and make a new adjustment.

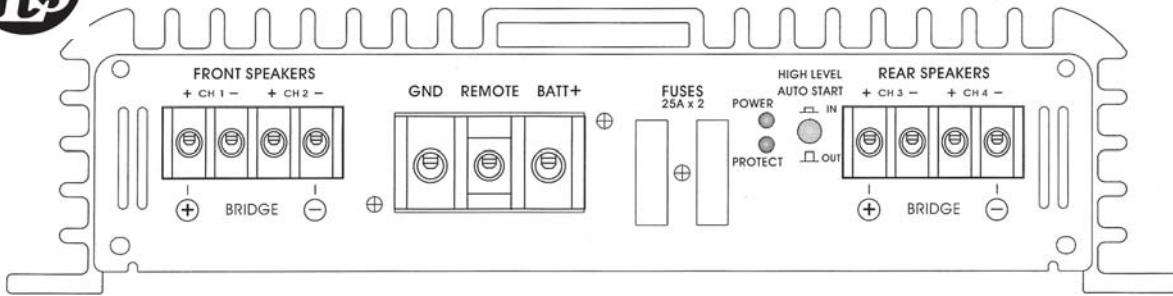

Speaker wiring RA40

RA40 is a 4-channel stereo amplifier. It can be connected either as a stereo amplifier for two pairs of fullrange speakers, or as a 3 channel amplifier with one pair of fullrange speakers in stereo, and one subwoofer connected in mono bridge mode.

Four fullrange speakers to RA40. One pair in front and one pair in rear.

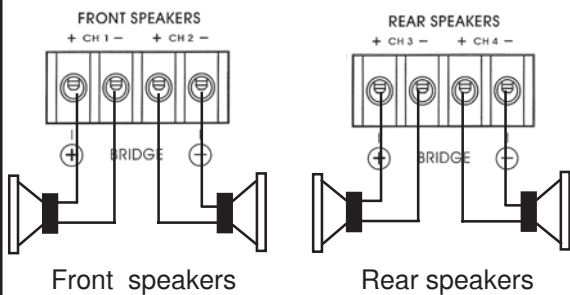

Two fullrange speakers and one subwoofer to RA40

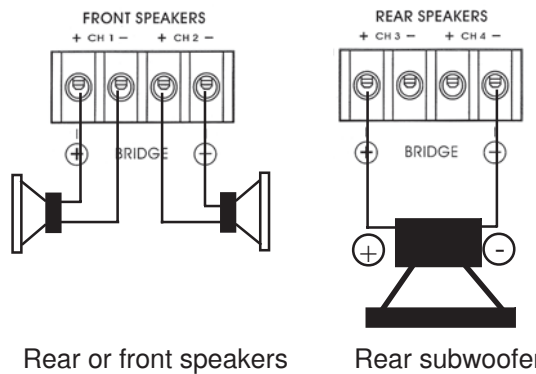

Filter settings channel 1 & 2

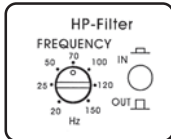

With the **HP-filter** in **OUT**-position the amplifier allows the speakers to play fullrange. If you for some reason want to limit the low bass reproduction switch on the HP-filter. The typical setting is then around 60 – 80 Hz.

Filter settings channel 1 & 2

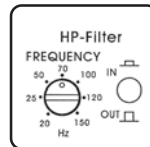

With the **HP-filter** in **OUT** position the amplifier allows the speakers to play fullrange. If you for some reason want to limit the low bass reproduction switch on the HP-filter. The typical setting is then around 60 – 80 Hz.

Filter settings channel 3 & 4

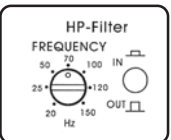

With the **HP-filter** in **OUT**-position the amplifier allows the speakers to play fullrange. If you for some reason want to limit the low bass reproduction switch on the HPF-filter (**IN**-position). The typical setting is then around 60 – 80 Hz.

Filter settings channel 3 & 4

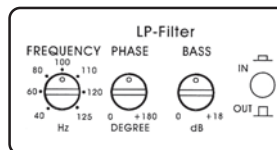

The **LP-filter** will allow low frequencies only and blocks higher frequencies. A typical setting is 70 – 90 Hz. When used with a subwoofer the switch should be in **IN**-position. Set the LP-filter to 70-90 Hz.

BASS is used to increase the bass volume with a center frequency of 40 Hz. You can select the amplification between 0 dB (no amplification) and +18 dB (full amplification).

The **phase control** can be set continuously from 0 - 180 degrees. This is very useful when you want to adjust the bass sound for best front stage image. Start on 0 and turn the control slowly clockwise until you experience that the bass sound is coming from the front. If you don't get the result you want, also try to phase reverse the subwoofer connections and make a new adjustment.

Two fullrange speakers connected in bridge mode to RA40

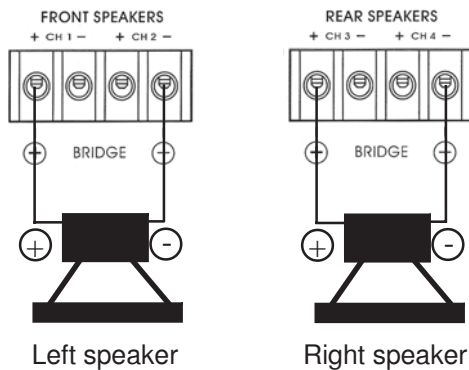

Filter settings channel 1, 2, 3 & 4

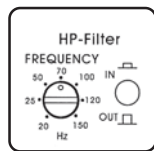

With the **HP-filter** in **OUT** position the amplifier allows the speakers to play fullrange. If you for some reason want to limit the low bass reproduction switch on the HP-filter. The typical setting is then around 60 – 80 Hz. The **LP-filter** should be in **OUT**-position.

Testing

Before you finish the installation, you should do the following tests to make sure the wiring is correct and everything is operating properly.

Reconnect Battery

When wiring is complete, reconnect the battery negative terminal.

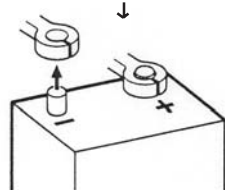

Test power wiring

1. Turn on the head unit but do not turn up the volume. The amplifier power light should come on. If not, check the remote and +12 volt wires. Also check the ground connection.
2. Turn up the head units volume slightly. All speakers should operate. if not, check wiring connections at amplifier and speakers.

Test speaker connections

Make sure the speakers are connected right. Use the balance control on the head unit to make sure right channel is on right speaker etc. If speakers don't play at all, one or both speaker wires may be disconnected.

Troubleshooting

If problems occur during the installation, or later, this guide might help you to find out what's wrong.

THE AMPLIFIER IS DEAD:

1. Check power lead, ground and remote connections at the amplifier using a multi meter.
2. Check the battery terminal connections.
3. Check the power lead fuse or circuit breaker. If fuse damage continues, inspect the power lead for short circuits.
4. Check the amplifier protection fuses. Are these broken change to new ones with the same value. If short circuiting continues, contact your local DLS dealer. A fault may exist in the amplifier.
5. To start the amplifier requires a remote voltage of 9-15 volt. Check the voltage with a multi meter.

AMPLIFIER PROTECTION FUSE BLOWS AT LOW VOLUME :

1. One or more speaker cables are shorted. Make an insulation test with a multi meter. The cables must not have a connection to earth.

THE AMPLIFIER TURNS OFF AFTER 10 - 30 MINUTES.

The amplifier is overheating due to inadequate ventilation. Check mounting position is free from obstruction.

Do this:

1. Move the amplifier to a place with better ventilation.
2. Install one or two fans to cool down the heat-sink.
3. Overheating can also be caused by an impedance load below the level permitted.

NO OUTPUT FROM ONE OR MORE SPEAKERS:

Check the following:

1. Balance control position.
2. Fader control position.
3. Speaker cable connections to both amplifier and drivers.
4. Signal lead plugs and cables.
5. Change left and right signal lead plugs in the amplifier to see if the problem moves to a different speaker, the lead has a fault. If the problem remains, the speaker or amplifier are at fault.

Professional Tip:

NOISE PROBLEMS

WHINING NOISE VARYING WITH ENGINE REVOLUTIONS:

Do this:

1. Rewire the power supply (12 V) to source unit direct from battery.
2. Rewire ground wire from source unit to clean position on chassis.
3. Check all power connections to ensure that they are clean and tight.
4. Check quality of system ground connection.
5. Install a Power Cap capacitor. This can be helpful against most noise problems.

CONSTANT WHINING NOISE:

Do this:

1. Ensure that all equipment has a common ground point.
2. Check quality of earth strap connection from battery negative terminal to chassis.
3. Disconnect signal cables from amplifier to see if noise disappears. If so the leads are picking up noise. Test this by laying a new cable over the seats and reconnecting to the amplifier. If the noise does not return, re-route original cable away from source of interference.

If noise remains regardless of cable position try to use so called Quasi-balanced signal cables. DLS PRO-cables are Quasibalanced.

Professional Tip:

Installing in trunk

When installing the amplifier in the trunk, run the power wires along the same path as the other vehicle wiring. Many cars have insulated channels for wiring. you will have to remove the door sill trim and the carpet.

Professional Tip:

Crimp connections

Purchase crimp connectors and crimping tool. Connectors are color coded.

1. Strip 1/4 inch (6 mm) of insulation from the wire.
2. Insert into connector
3. Crimp tightly

Professional Tip:

SPEAKER POLARITY CHECK.

All speakers in a car audio system should be connected in phase (the same polarity). All speaker cones must move in the same direction. Out of phase speakers will cause a lack of bass, and a poor stereo soundstage.

Checking polarity:

Hold the - connection of the speaker wire to the - terminal of a 1,5 Volt flashlight battery. Tap the + wire on to the + terminal of the battery, and observe the movement of the cone. The cone should move outwards when the wire touches the battery, and inwards when the battery is removed. If it is the other way around, the speaker has been connected backwards and it must be removed and connected correctly.

If your system also has a subwoofer connected through a passive 6 or 12 dB crossover, try to connect this with various polarity and judge what sounds best. The phase shift in passive crossovers sometimes makes it necessary to change polarity.

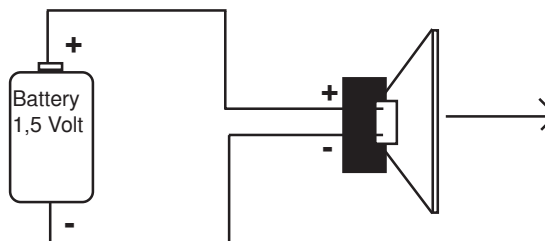

NOTE! Tweeters can not be tested this way, double check the connections instead.

Professional Tip:

Securing wires

Use wire ties to bundle together when possible. (But never bundle speaker wires or signal cables together with power wires.)



Professional Tip:

Speaker and power wires

Do not run speaker and power wires next to each other. Power wires can generate a "siren" sound in the speakers. Run speaker and power wires on opposite sides of the car.



Specifications

DLS CLASSIC	RA20	RA40
Number of channels	2	4
Working mode	AB	AB
Power output at 13,8 Volt, 20 Hz - 20 kHz, max 0,1 % THD		
Power output, 4 ohm	2 x 130 W	4 x 75 W
Power output, 2 ohm	2 x 220 W	4 x 110 W
Power output, 4 ohm bridged	1 x 440 W	2 x 220 W
THD @1 W	< 0,1%	< 0,1%
Signal to noise ratio, A-weighted	>100 dB	>100 dB
Damping factor	>200	>200
Frequency response +/- 0,5 dB	10 Hz - 50 kHz	10 Hz - 50 kHz
Input impedance, low level	>10 kohm	>10 kohm
Input impedance, high level	330 ohm	330 ohm
High level input with auto start	Yes	Yes
Input sensitivity	0,2 - 7V	0,2 - 7V
Pre amp configuration on Front channel:		
Filter high pass	20 - 150 Hz*	20 - 150 Hz*
Filter low pass	40 - 125 Hz*	No
Phase shift 0- 180 degrees contiously	Yes	No
Grand bass adjustable gain @ 40 Hz	0 - +18 dB	No
Pre amp configuration on Rear channel:		
Filter highpass	No	20 - 150 Hz*
Filter lowpass	No	40 - 125 Hz*
Phase shift 0- 180 degrees contiously	No	Yes
Grand bass adjustable gain @ 40 Hz	No	0 - +18 dB
* can be switched in/out		
Filter slope	12 dB/octave	12 dB/octave
Protection	current & thermal	current & thermal
Max cable size, DC input	4 AWG, 21 mm ²	4 AWG, 21 mm ²
Max cable size, speakers	5 AWG, 16 mm ²	7 AWG, 10 mm ²
Power consumption:		
Idle	0,6 A	0,9 A
Maximum	50 A	50 A
Fuse	2 x 25 A	2 x 25 A
Dimensions HxWxD(mm)	59x359x245	59x359x245
Dimensions (inch)	2,33x14,1x9,65	2,33x14,1x9,65
Weight	3,8 kg (8,4 lbs)	4,0 kg (8,8 lbs)

NOTE!

The amplifiers are two (2) ohm stable. In stereo mode it's possible to load the amplifier down to two ohm on each channel.

In mono bridge mode it's possible to load with one four ohm fullrange speaker or subwoofer.

(In bridge mode the amplifier sees a four ohm speaker as a two ohm load).

We follow a policy of continuous advancement in development.

For this reason all or part of specifications & designs may be changed without prior notice.



DLS Svenska AB
P.O. Box 13029
SE-40251 Göteborg, Sweden
Tel: +46 31 840060
Fax: +46 31 844021
E-mail: info@dls.se
www.dls.se